

FOR PCR/LTR TBM

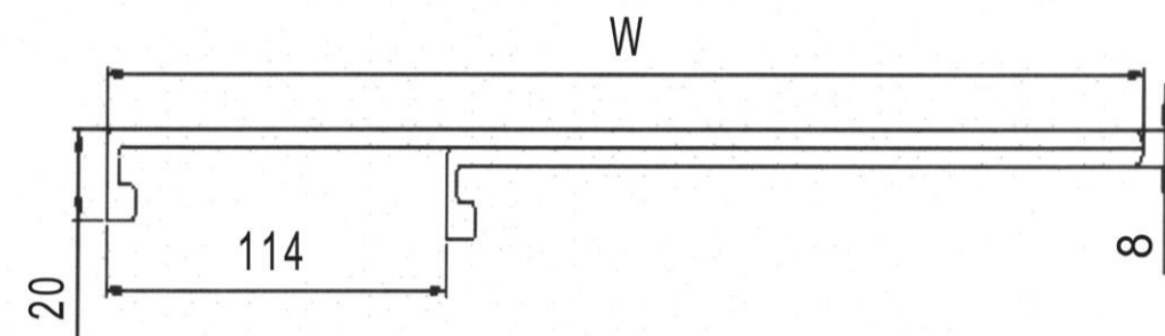

Turn Up Bladder	Specification	
	Size	Width(Min ~ Max)
	14" ~ 20"	320 ~ 380

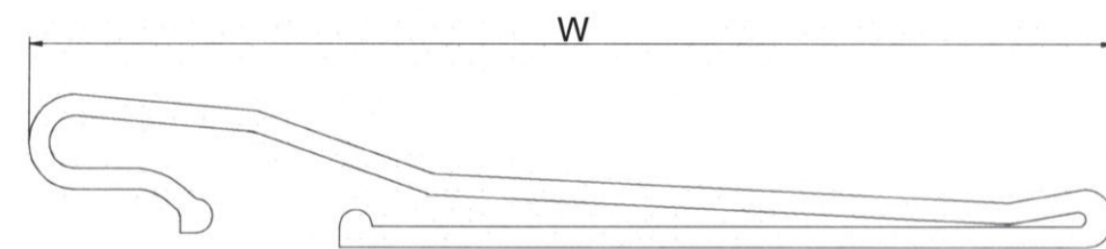

Turn Up Bladder	Specification	
	Size	Width
	12" ~ 17"	210
15" ~ 20"	235	

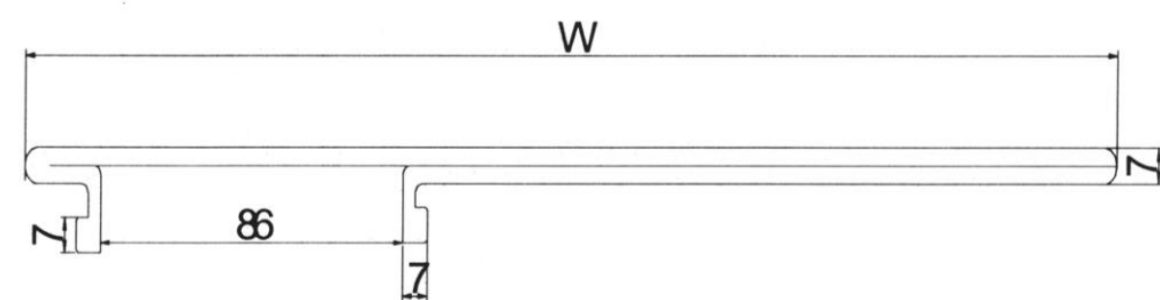

Turn Up Bladder	Specification	
	Size	Width(Min ~ Max)
	13" ~ 22"	280 ~ 340

FOR PCR/LTR TBM

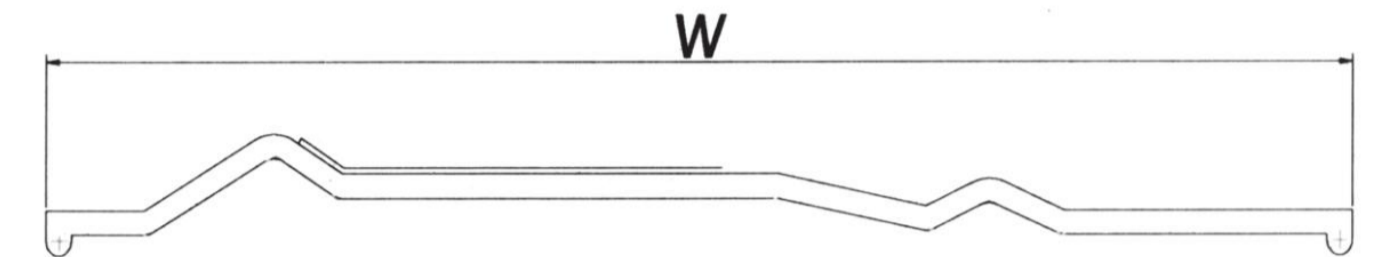

Turn Up Bladder	Specification	
	Size	Width(Min ~ Max)
	14" ~ 20"	320 ~ 380

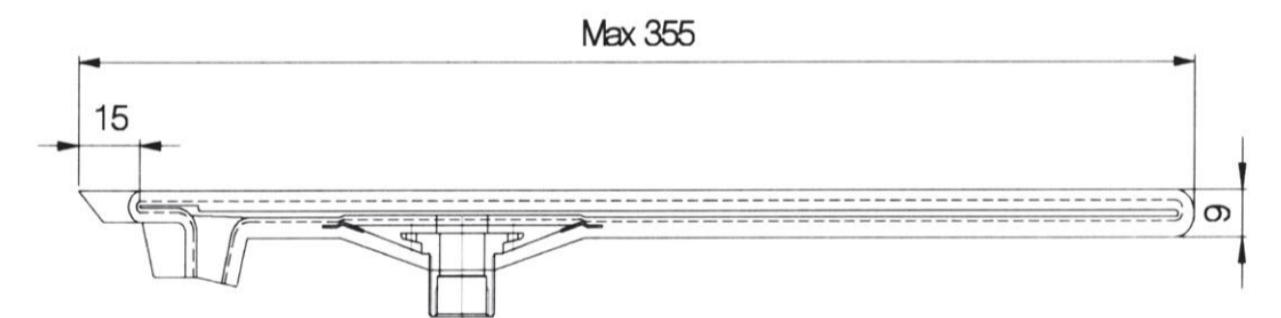

Turn Up Bladder	Specification	
	Size	Width
	14" ~ 20"	355

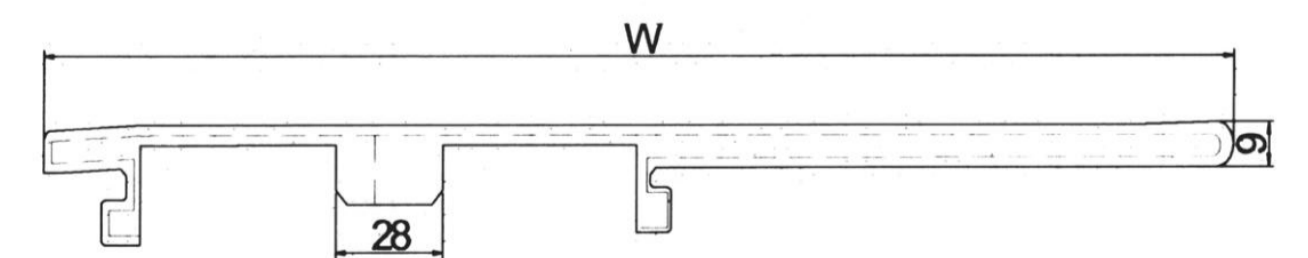

Turn Up Bladder	Specification	
	Size	Width(Min ~ Max)
	14" ~ 20"	310 ~ 360

FOR PCR/LTR TBM

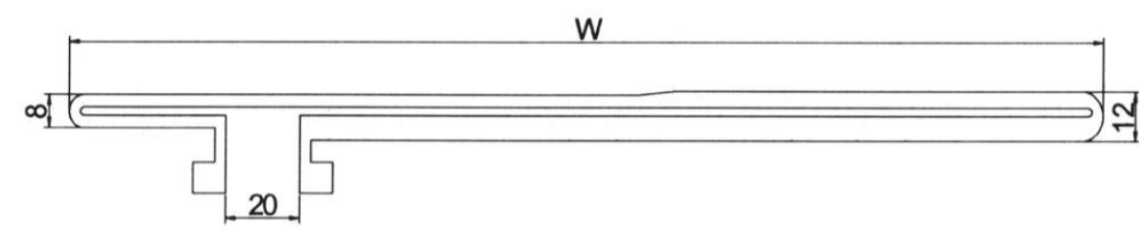

Turn Up Bladder	Specification	
	Size	Width(Min ~ Max)
	12" ~ 17"	220 ~ 240

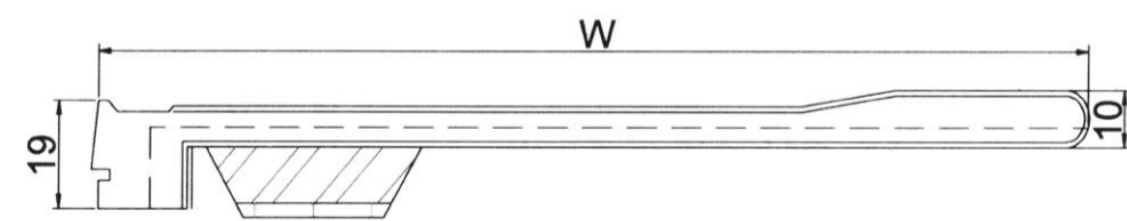

Turn Up Bladder	Specification	
	Size	Width(Min ~ Max)
	13" ~ 17"	200 ~ 260

FOR PCR/LTR TBM

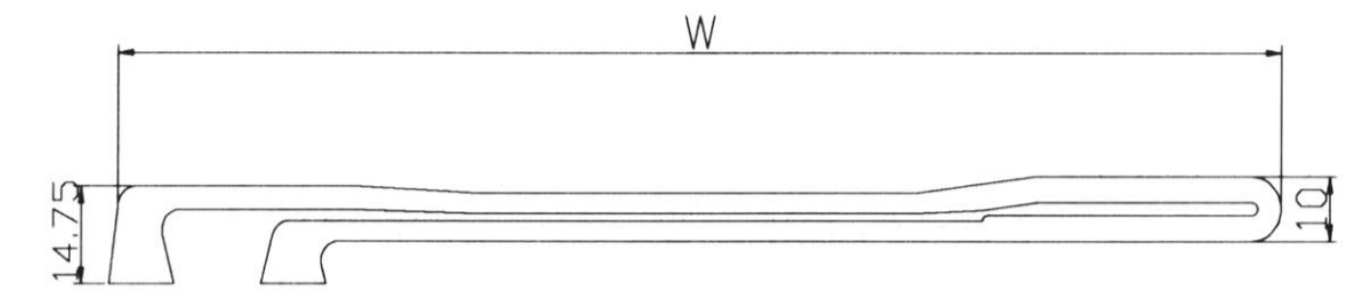

Push Up Bladder	Specification	
	Size	Width(Min ~ Max)
	13" ~ 17"	180 ~ 230

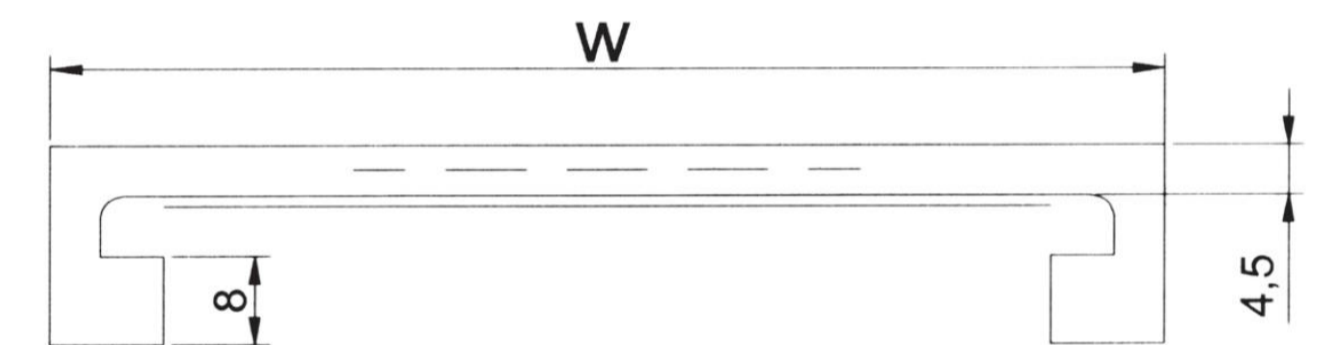

Shaping Drum Sleeve	Specification	
	Size	Width(Min ~ Max)
	13" ~ 20"	88 ~ 128

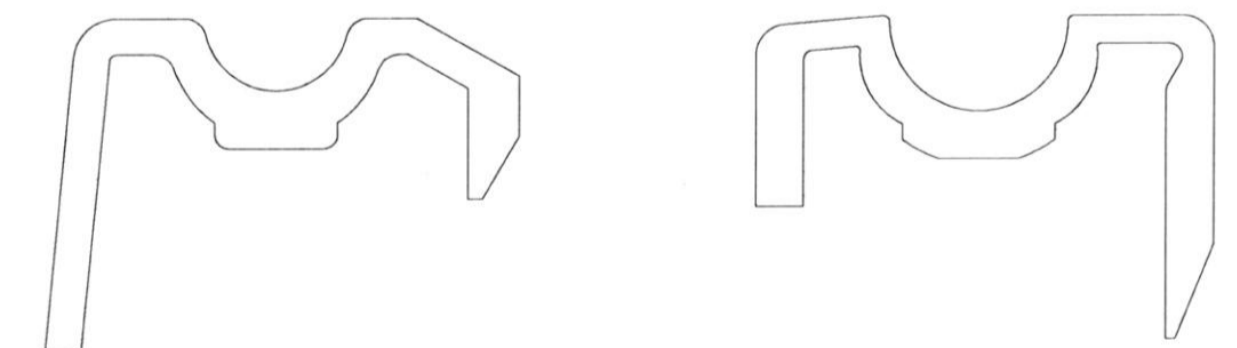

Shaping Drum Sleeve	Specification	
	Size	Width(Min ~ Max)
	12" ~ 20"	57 ~ 62
15" ~ 18"	68 ~ 75	

FOR PCR/LTR TBM

FOR TBR TBM

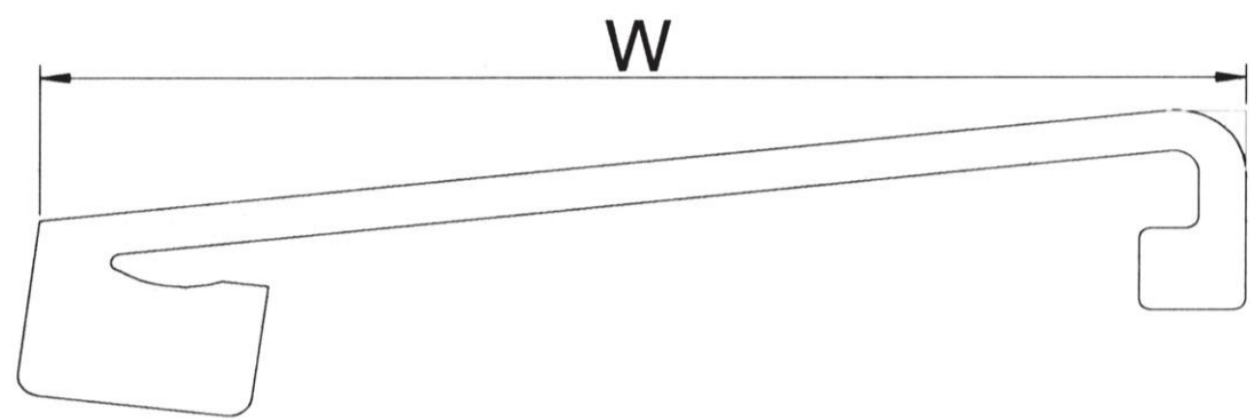

Shaping Drum Sleeve	Specification	
	Size	Width
	14" ~ 24"	102

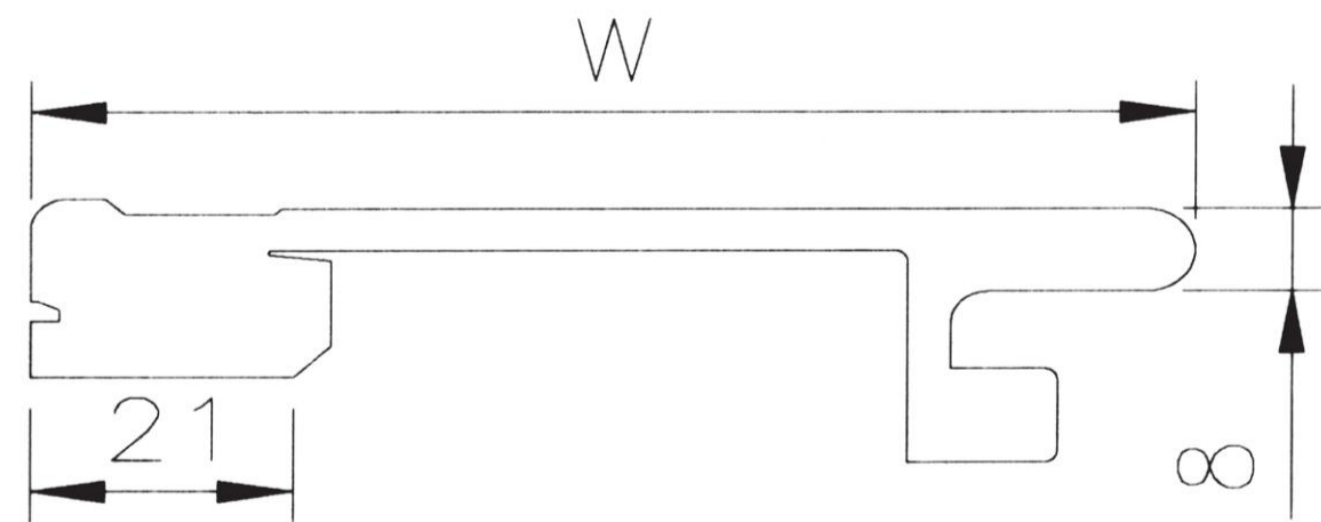

Shaping Drum Sleeve	Specification	
	Size	Width (Min ~ Max)
	15" ~ 20"	83 ~ 93

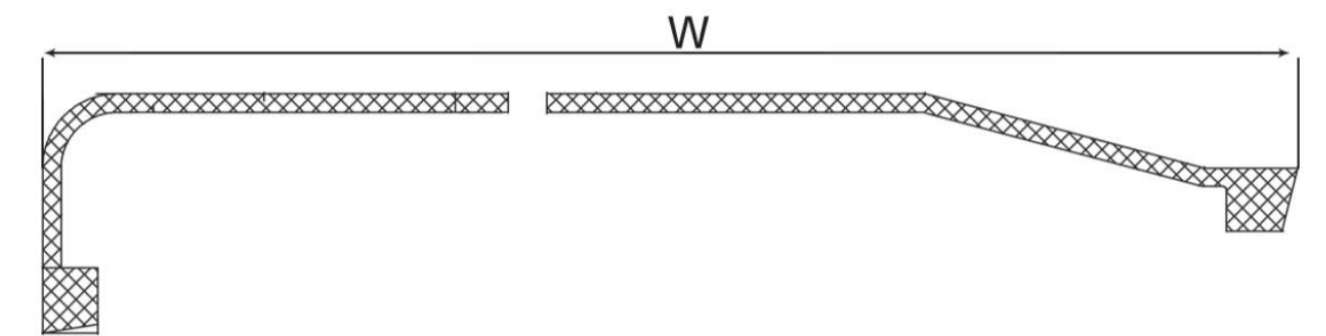
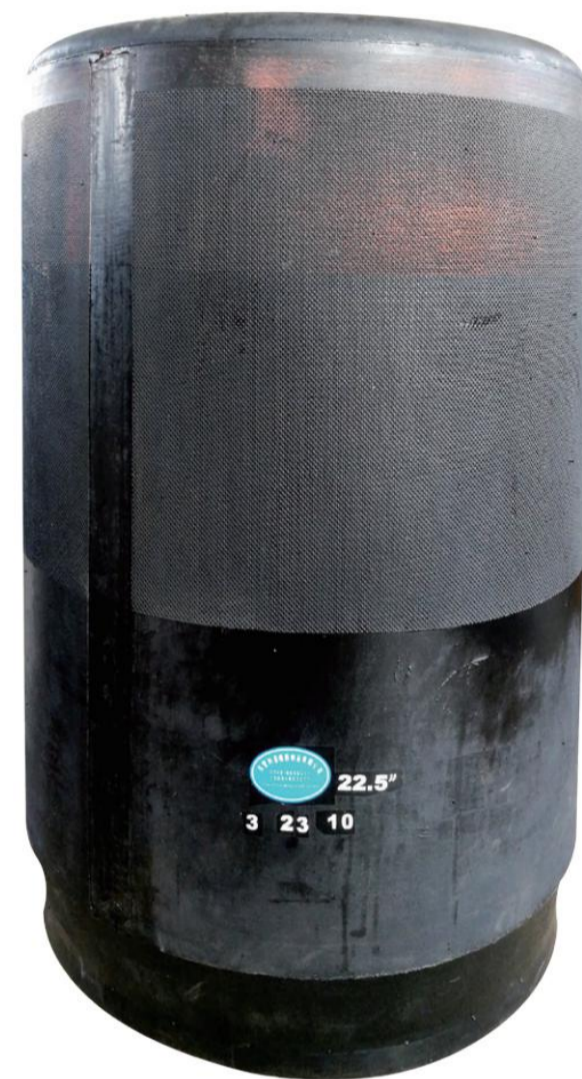

Turn Up Bladder	Specification	
	Size	Width
	15" ~ 24.5"	730

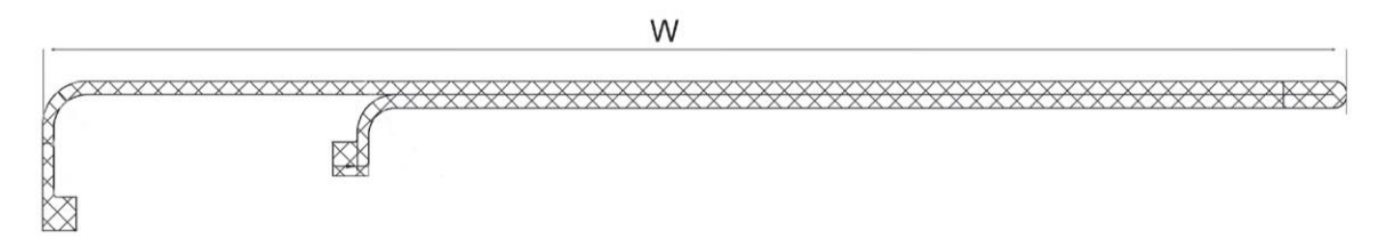

Turn Up Bladder	Specification	
	Size	Width (Min ~ Max)
	15" ~ 24.5"	420 ~ 730

FOR TBR TBM

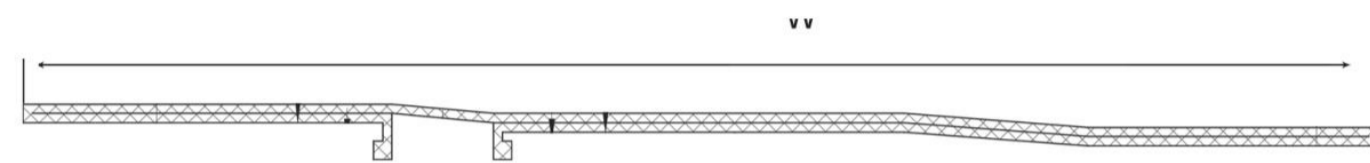

Turn Up Bladder	Specification	
	Size	Width(Min ~ Max)
	15" ~ 24.5"	600 ~ 860

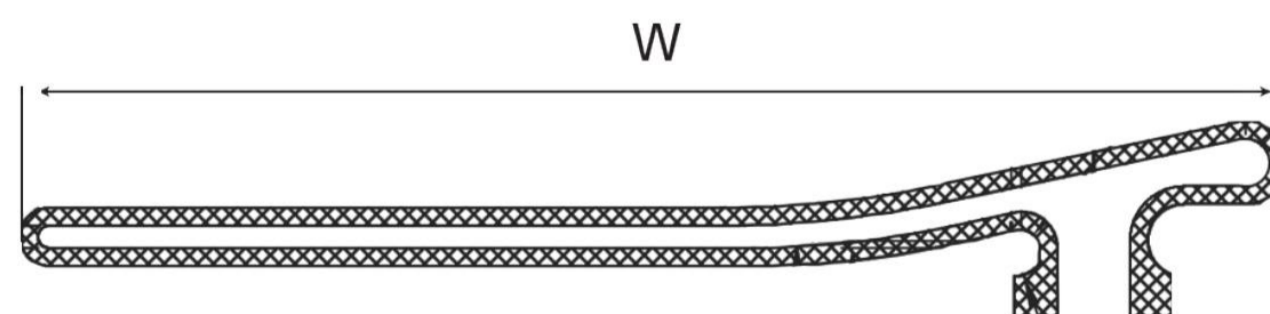

Turn Up Bladder	Specification	
	Size	Width(Min ~ Max)
	16" ~ 22.5"	350 ~ 450

FOR TBR TBM

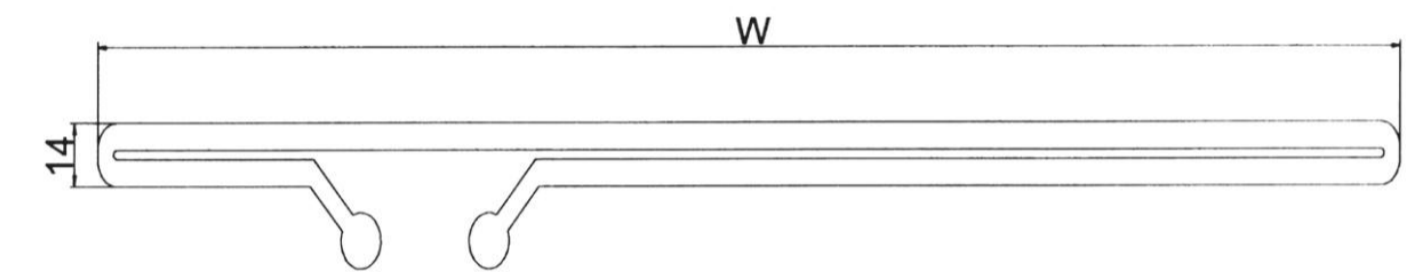

Turn Up Bladder	Specification	
	Size	Width
	20" ~ 24"	420

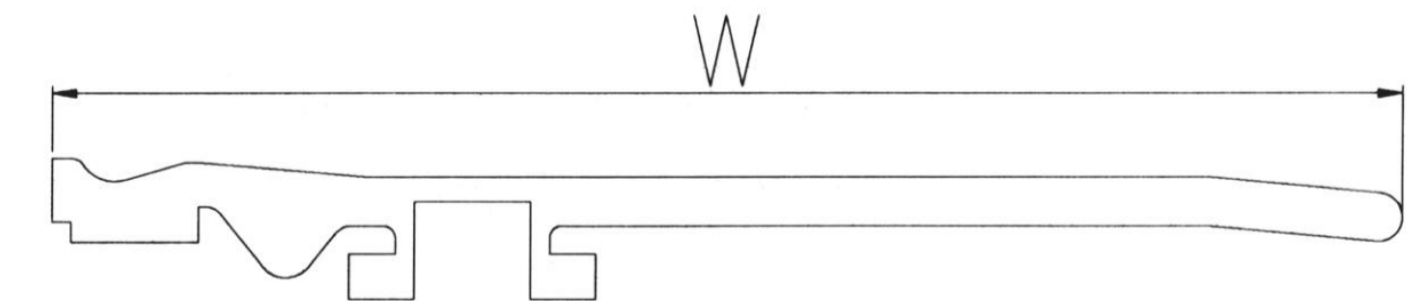

Turn Up Bladder	Specification	
	Size	Width(Min ~ Max)
	16.5" ~ 22.5"	340 ~ 370

FOR TBR TBM

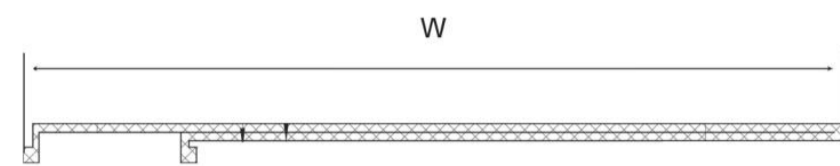

Push Up Bladder	Specification	
	Size	Width(Min ~ Max)
	15" ~ 24.5"	400 ~ 600

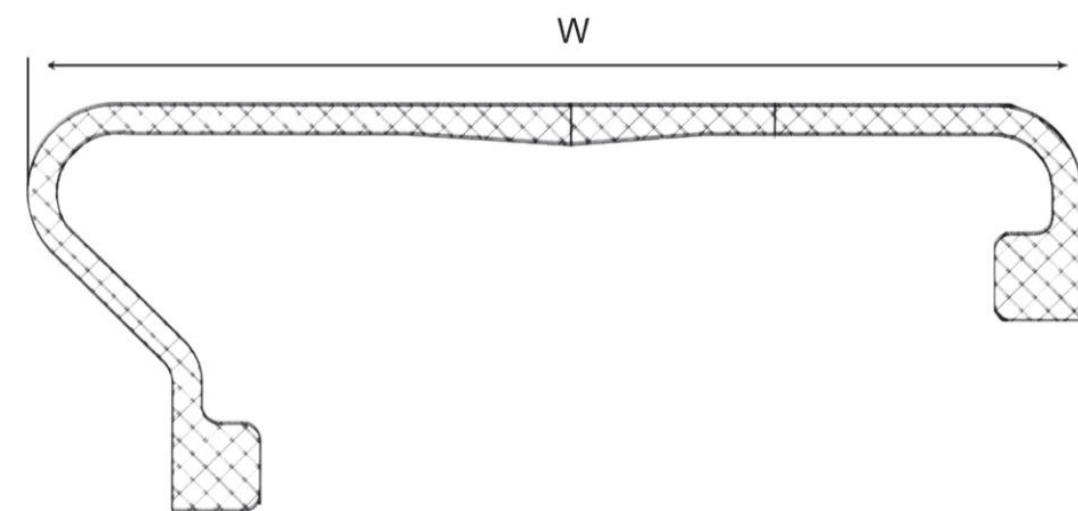

Shaping Drum Sleeve	Specification	
	Size	Width
	16" ~ 24.5"	170

FOR TBR TBM

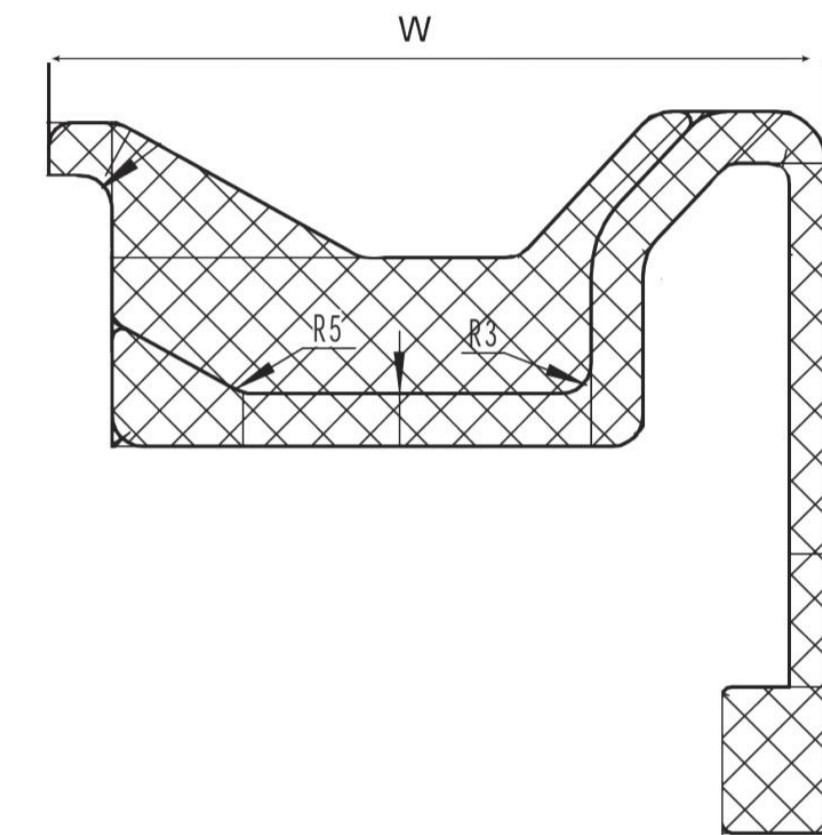

Shaping Drum Sleeve	Specification	
	Size	Width
	16" ~ 24.5"	110

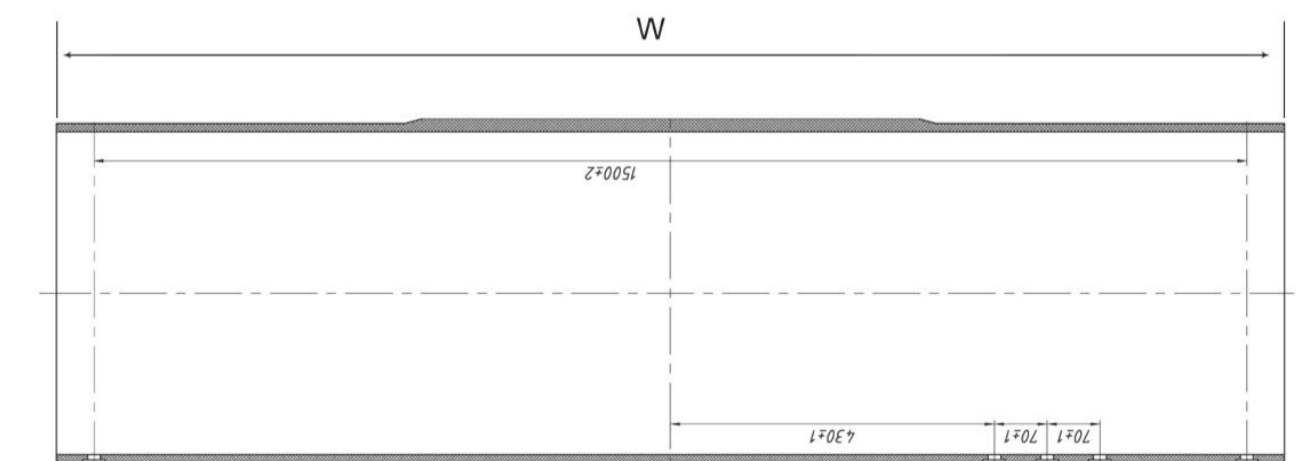

Carcass Drum Sleeve	Specification	
	Size	Width(Min ~ Max)
	16" ~ 24.5"	970 ~ 1700

FOR OTR TBM

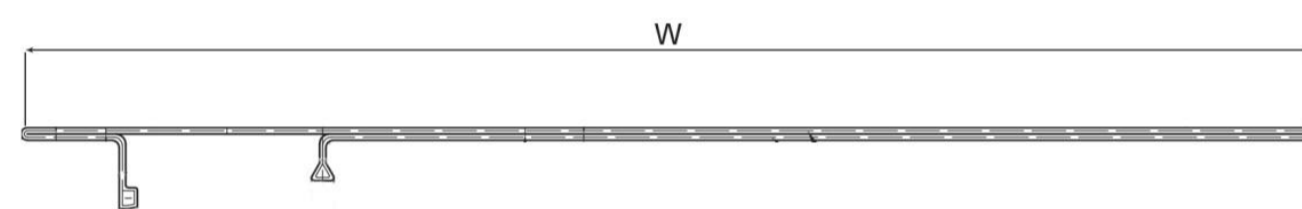

Turn Up Bladder	Specification	
	Size	Width(Min ~ Max)
	22" ~ 39"	850 ~ 1300

FOR OTR TBM

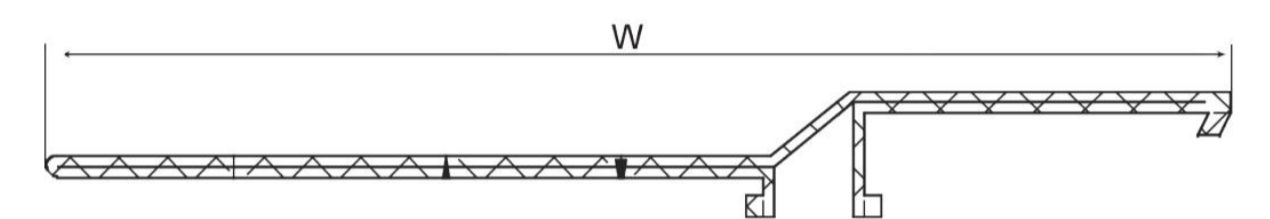

Turn Up Bladder	Specification	
	Size	Width(Min ~ Max)
	25" ~ 35"	500 ~ 760

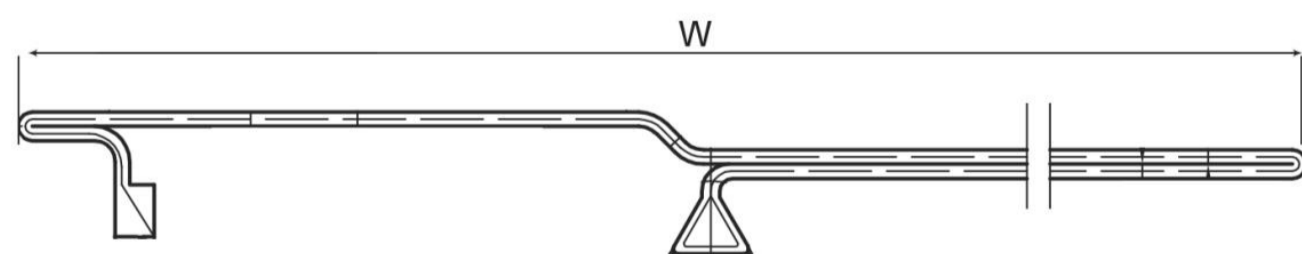

Turn Up Bladder	Specification	
	Size	Width(Min ~ Max)
	45" ~ 63"	960 ~ 1200

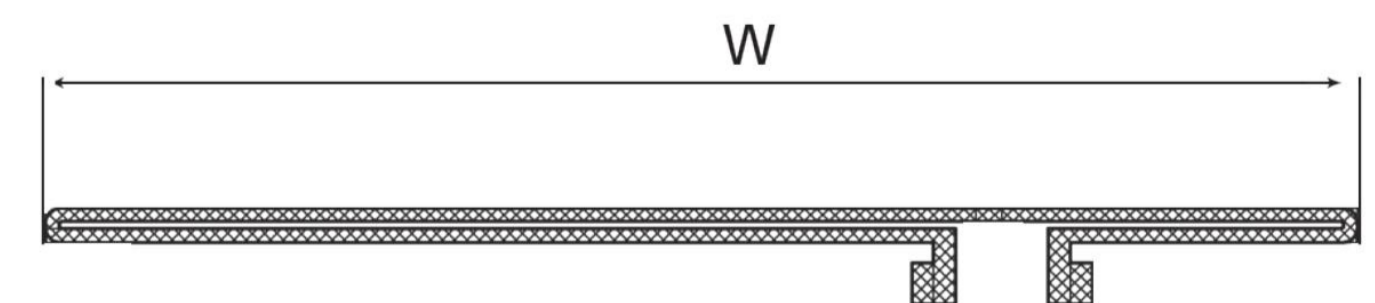

Turn Up Bladder	Specification	
	Size	Width(Min ~ Max)
	16" ~ 63"	350 ~ 1050

FOR OTR TBM

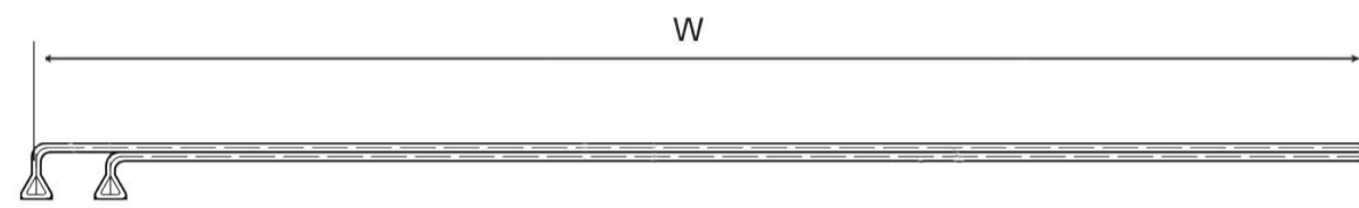

Push Up Bladder	Specification	
	Size	Width(Min ~ Max)
	25" ~ 49"	650 ~ 1050

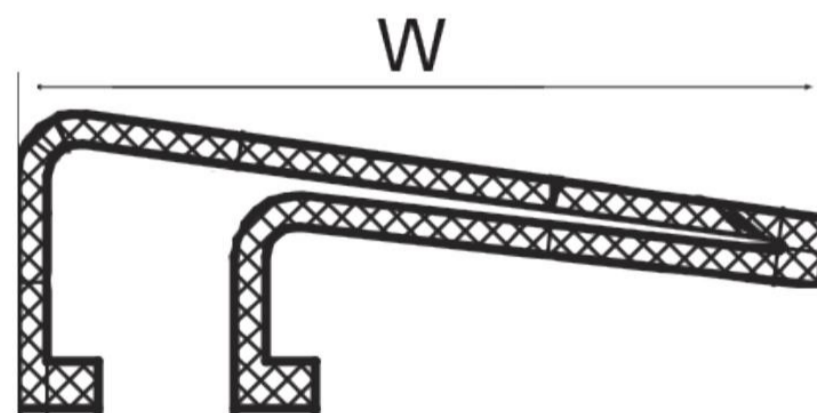

Shaping Drum Bladder	Specification	
	Size	Width(Min ~ Max)
	20" ~ 51"	170 ~ 210

FOR OTR TBM

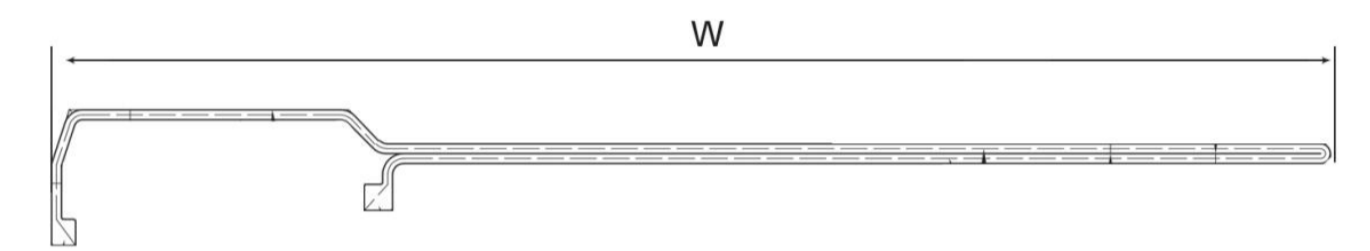

Turn Up Bladder	Specification	
	Size	Width(Min ~ Max)
	25" ~ 35"	585 ~ 800

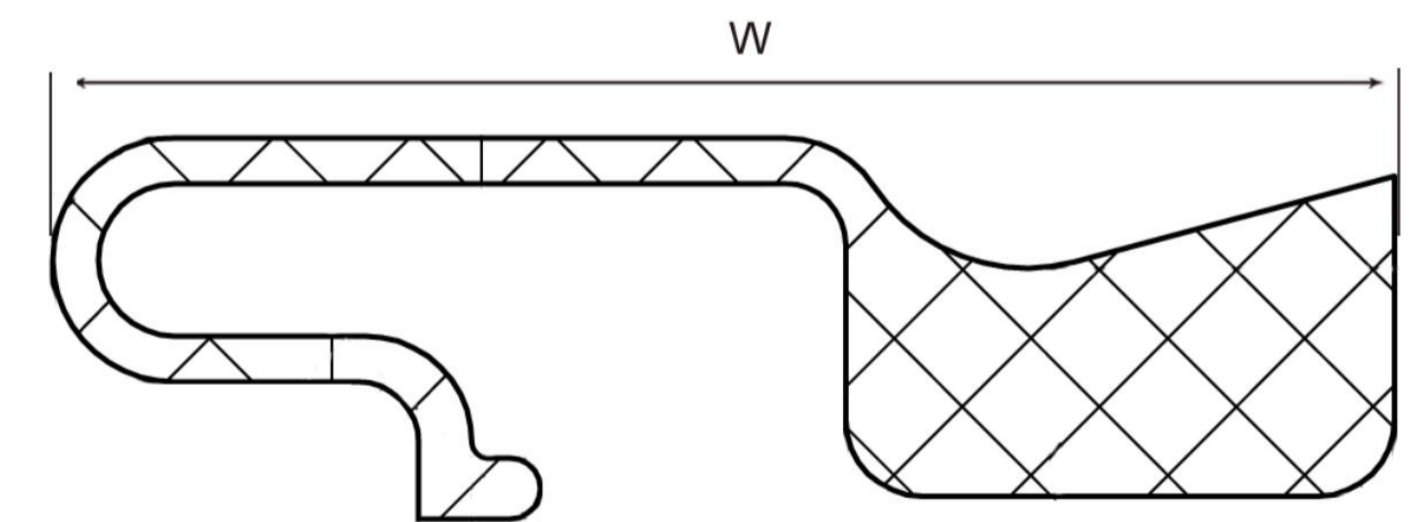

Shaping Drum Sleeve	Specification	
	Size	Width(Min ~ Max)
	25" ~ 35"	90 ~ 160